

8 7 6 5 4 3 2 1

D  
C  
B  
A

D  
C  
B  
A

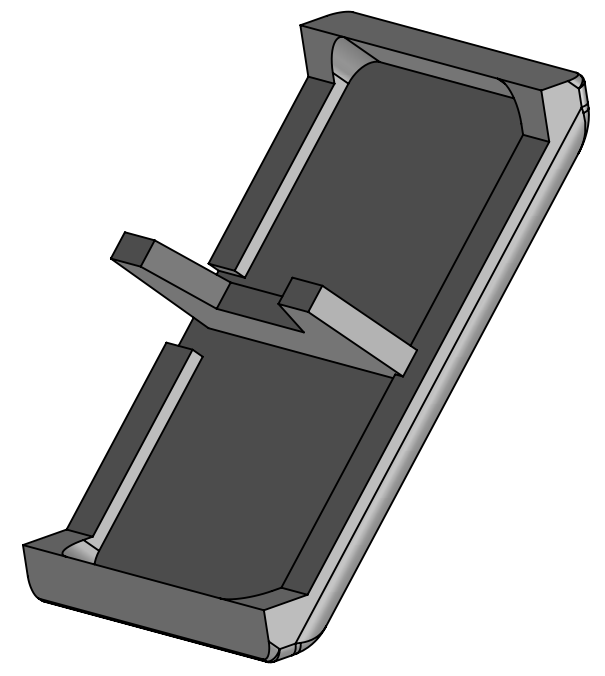
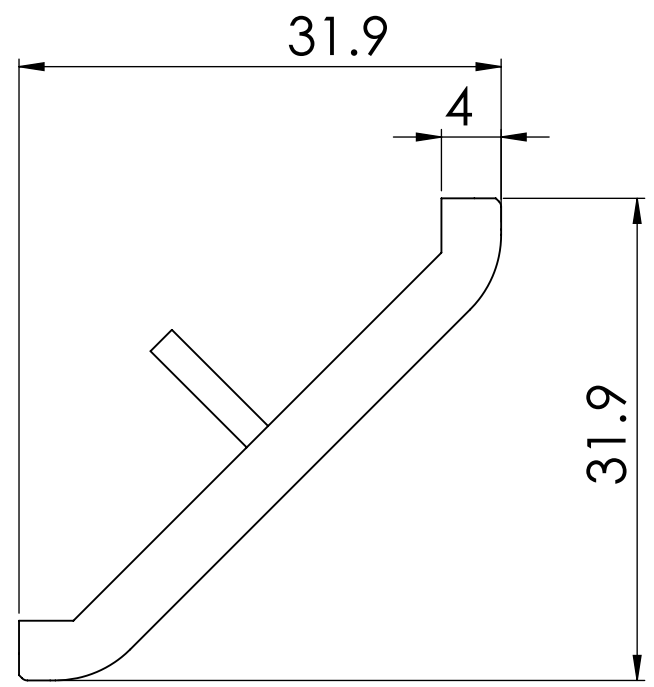
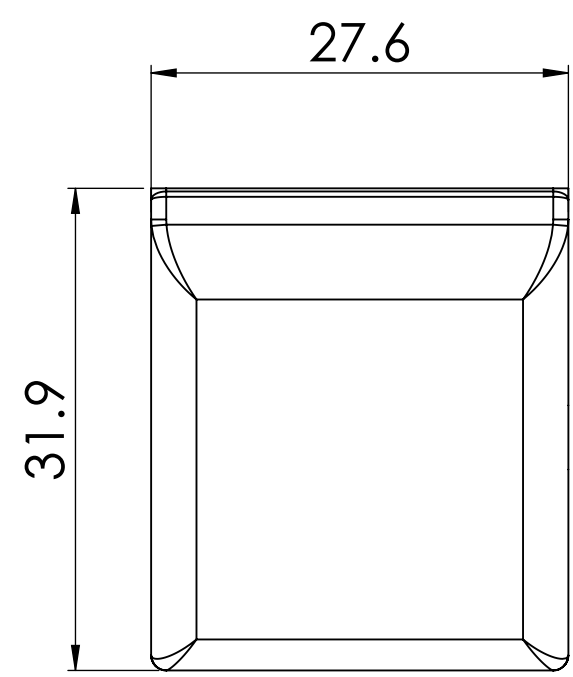

NOTE :-  
ALL UNMENTIONED FILLETS ARE 0.2 MM

		UNLESS OTHERWISE SPECIFIED:		NAME	DATE			
		DIMENSIONS ARE IN MILLIMETERS		DRAWN		TITLE:		
		TOLERANCES:		CHECKED				
		FRACTIONAL ±		ENG APPR.				
		ANGULAR: MACH ± BEND ±		MFG APPR.				
		TWO PLACE DECIMAL ±		Q.A.		SIZE	DWG. NO.	REV
		THREE PLACE DECIMAL ±		PROJECTION:		<b>B</b>	482523534	
		INTERPRET GEOMETRIC TOLERANCING PER: ISO 2768 MEDIUM				SCALE: 2:1	WEIGHT:	SHEET 1 OF 1
		MATERIAL						
NEXT ASSY	USED ON	FINISH		DEBURR AND BREAK SHARP EDGES				
APPLICATION		DO NOT SCALE DRAWING						

8 7 6 5 4 3 2 1