

8 7 6 5 4 3 2 1

D  
C  
B  
A

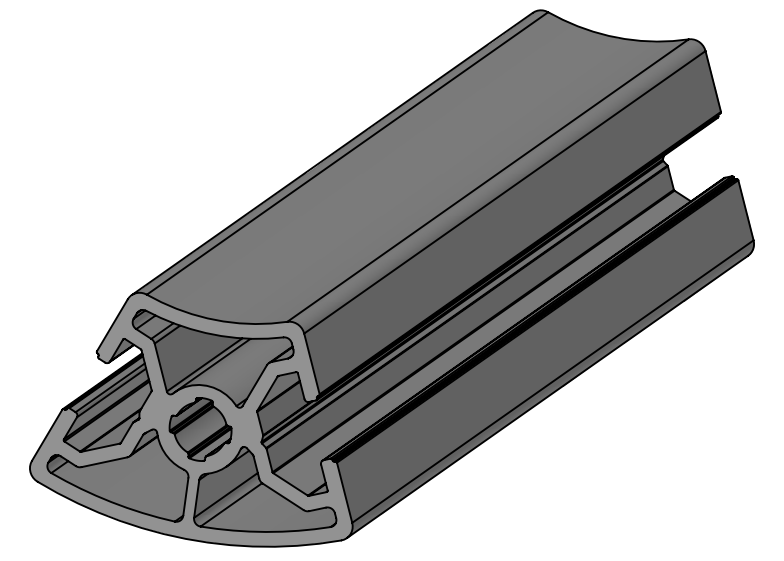
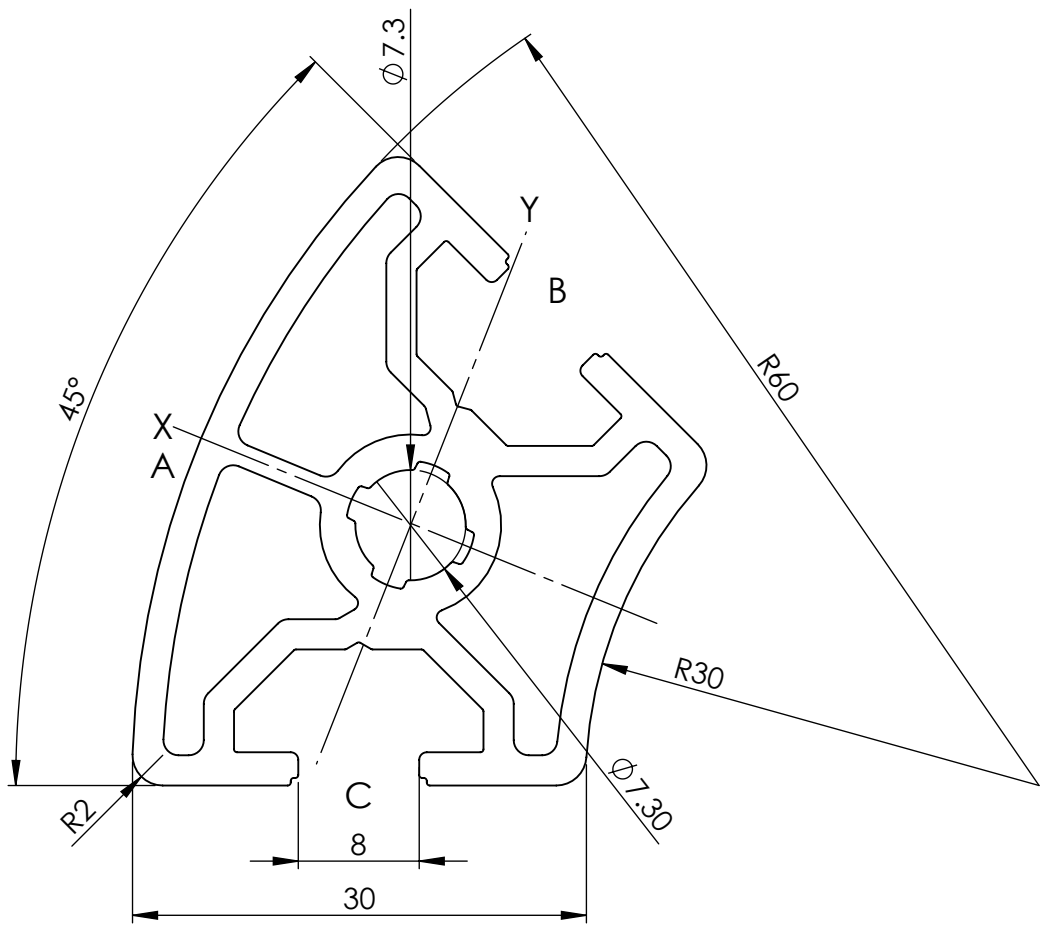

D  
C  
B  
A

NOTE :-  
ALL UNMENTIONED FILLETS ARE 0.2 MM

		UNLESS OTHERWISE SPECIFIED:		NAME	DATE		
		DIMENSIONS ARE IN MILLIMETERS		DRAWN		TITLE:	
		TOLERANCES:		CHECKED			
		FRACTIONAL $\pm$		ENG APPR.			
		ANGULAR: MACH $\pm$ BEND $\pm$		MFG APPR.			
		TWO PLACE DECIMAL $\pm$		Q.A.		SIZE DWG. NO. REV	
		THREE PLACE DECIMAL $\pm$		PROJECTION:			
		INTERPRET GEOMETRIC TOLERANCING PER: ISO 2768 MEDIUM		THIRD ANGLE PROJECTION		B 481993011	
		MATERIAL					
NEXT ASSY	USED ON	FINISH		DEBURR AND BREAK SHARP EDGES		SCALE: 1:2	WEIGHT:
APPLICATION		DO NOT SCALE DRAWING				SHEET 1 OF 1	

8 7 6 5 4 3 2 1