

8 7 6 5 4 3 2 1

D  
C  
B  
A

D  
C  
B  
A

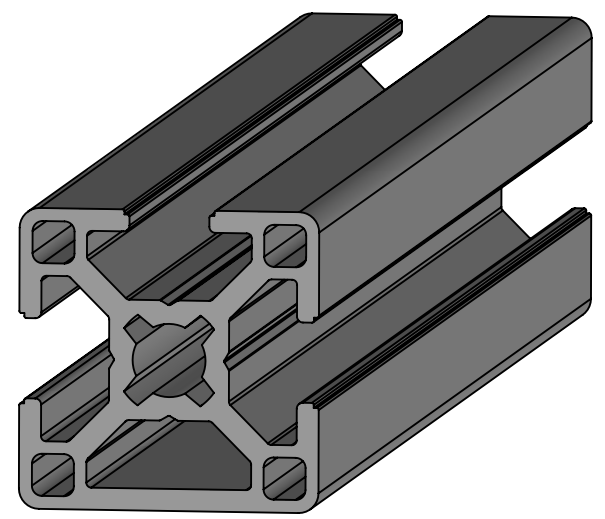
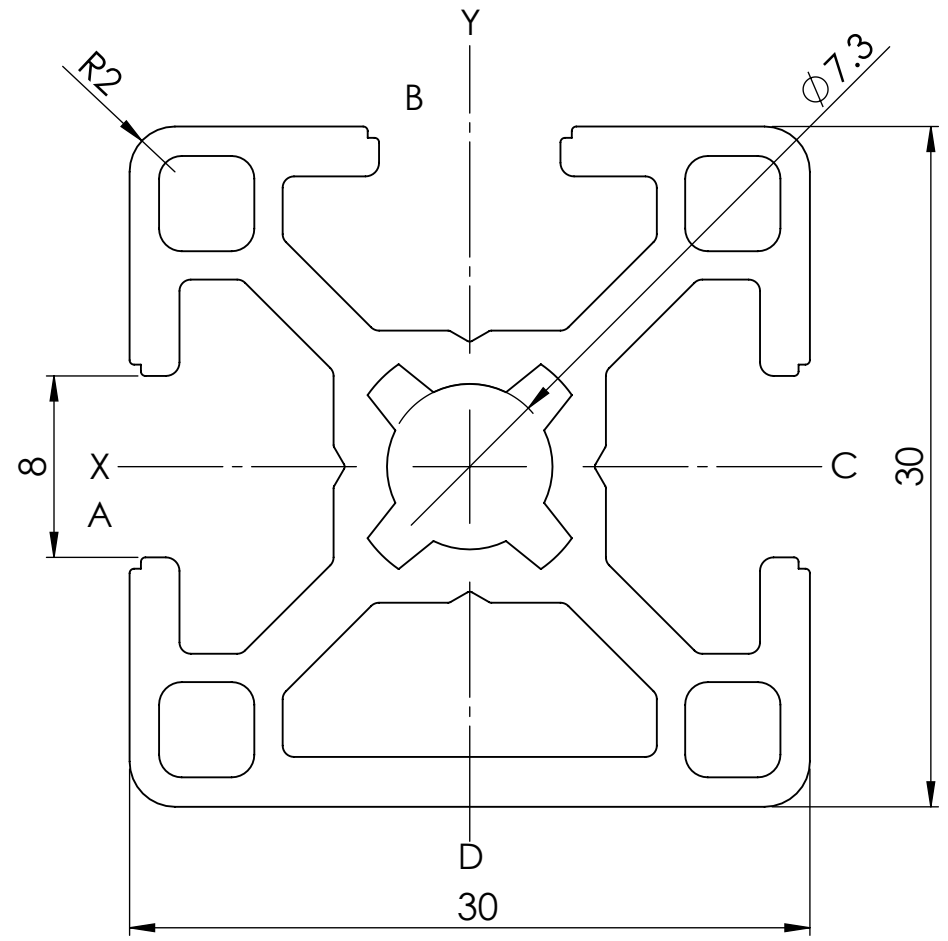

NOTE :-  
ALL UNMENTIONED FILLETS ARE 0.2 MM

		UNLESS OTHERWISE SPECIFIED:	NAME	DATE		
		DIMENSIONS ARE IN MILLIMETERS	DRAWN		TITLE:	
		TOLERANCES:	CHECKED			
		FRACTIONAL ±	ENG APPR.			
		ANGULAR: MACH ± BEND ±	MFG APPR.			
		TWO PLACE DECIMAL ±	Q.A.		SIZE DWG. NO. REV	
		THREE PLACE DECIMAL ±	PROJECTION:			
		INTERPRET GEOMETRIC TOLERANCING PER: ISO 2768 MEDIUM	THIRD ANGLE PROJECTION		B 481992400	
		MATERIAL				
NEXT ASSY	USED ON	FINISH	DEBURR AND BREAK SHARP EDGES		SCALE: 1:2	WEIGHT:
APPLICATION		DO NOT SCALE DRAWING			SHEET 1 OF 1	

8 7 6 5 4 3 2 1