

4

3

2

1

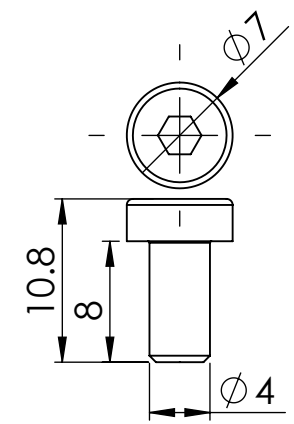
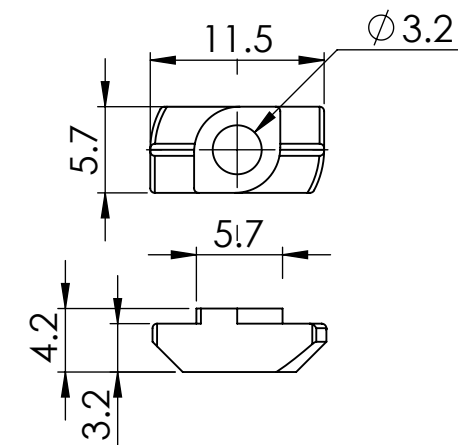
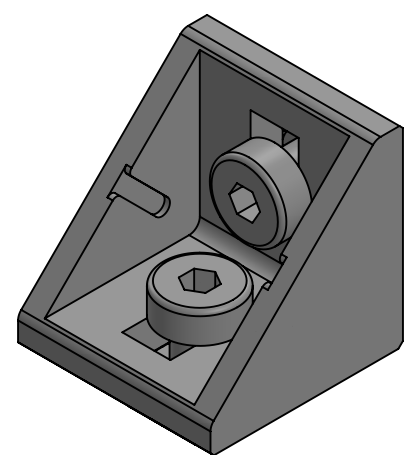
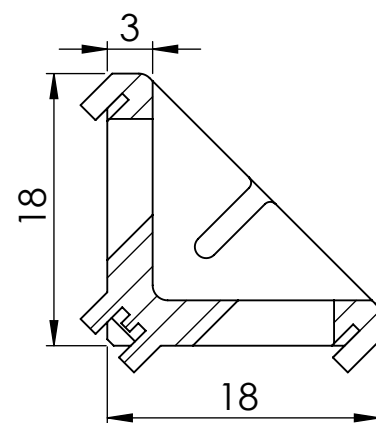
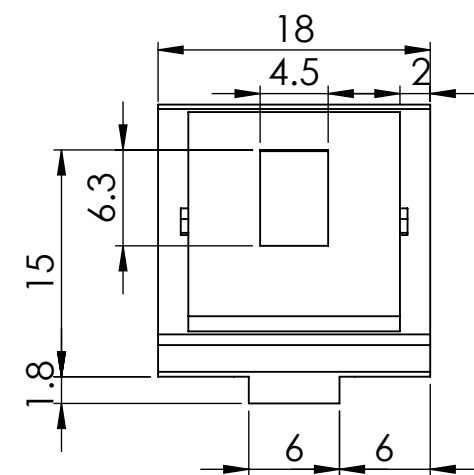

B

B

A

A

Note:-
*ALL UNMENTIONED FILLETS ARE 0.2MM

		UNLESS OTHERWISE SPECIFIED:		NAME	DATE	
		DIMENSIONS ARE IN MILLIMETERS	DRAWN			TITLE:
		TOLERANCES:	CHECKED			
		FRACTIONAL ±	ENG APPR.			
		ANGULAR: MACH ± BEND ±	MFG APPR.			
		TWO PLACE DECIMAL ±	Q.A.			
		THREE PLACE DECIMAL ±	Projection:-			
		INTERPRET GEOMETRIC TOLERANCING PER:ISO 2768 MEDIUM	THIRD ANGLE PROJECTION			SIZE DWG. NO. REV
		MATERIAL				B 462538707
		FINISH				
NEXT ASSY	USED ON					
APPLICATION		DO NOT SCALE DRAWING	DEBURR AND BREAK SHARP EDGES	SCALE: 2:1	WEIGHT:	SHEET 1 OF 1

4

3

2

1