

8 7 6 5 4 3 2 1

D
C
B
A

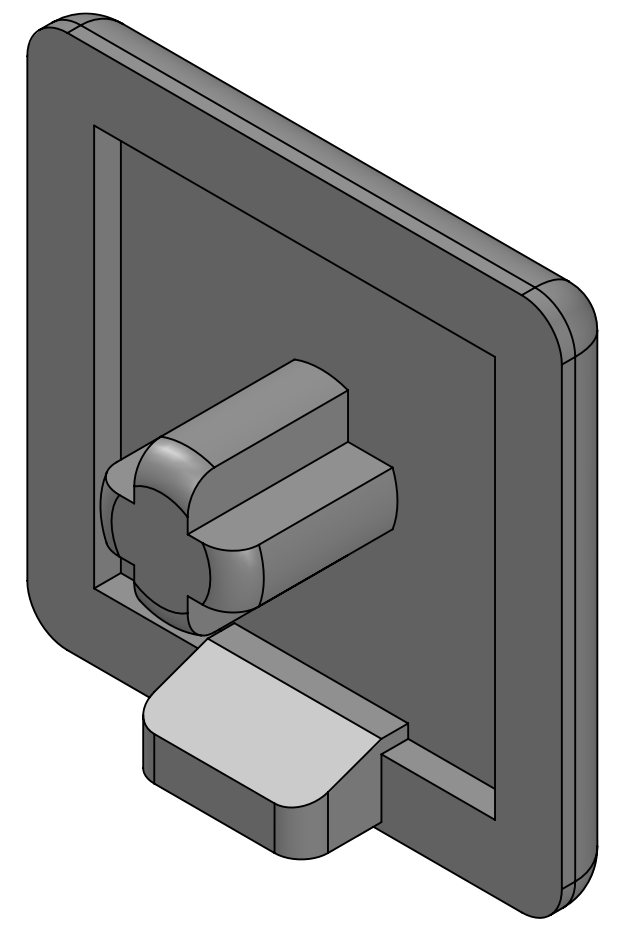
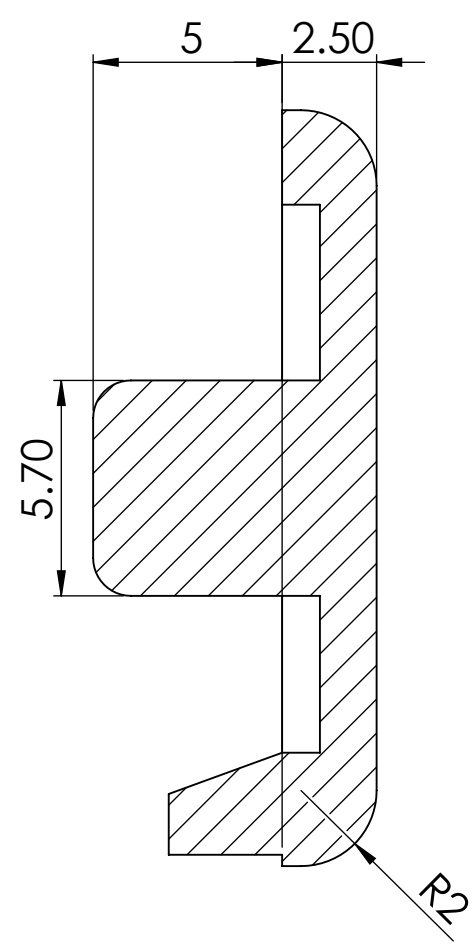
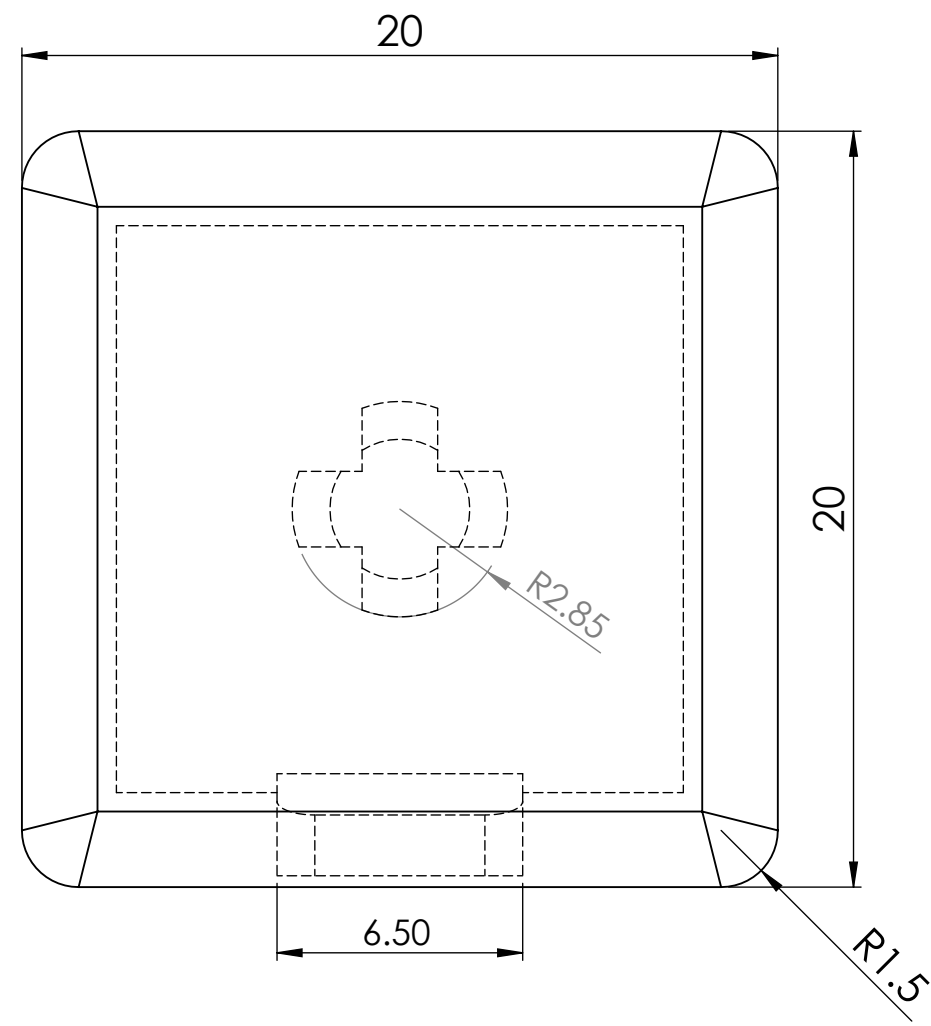

D
C
B
A

NOTE :-
ALL UNMENTIONED FILLETS ARE 0.2 MM

		UNLESS OTHERWISE SPECIFIED:	NAME	DATE		
		DIMENSIONS ARE IN MILLIMETERS	DRAWN		TITLE:	
		TOLERANCES:	CHECKED			
		FRACTIONAL ±	ENG APPR.			
		ANGULAR: MACH ± BEND ±	MFG APPR.			
		TWO PLACE DECIMAL ±	Q.A.		SIZE	DWG. NO.
		THREE PLACE DECIMAL ±	PROJECTION:		B	461548743
		INTERPRET GEOMETRIC TOLERANCING PER: ISO 2768 MEDIUM	THIRD ANGLE PROJECTION		REV	
		MATERIAL	DEBURR AND BREAK SHARP EDGES		SCALE: 5:1	WEIGHT:
NEXT ASSY	USED ON	FINISH				SHEET 1 OF 1
APPLICATION		DO NOT SCALE DRAWING				

8 7 6 5 4 3 2 1