

8 7 6 5 4 3 2 1

D
C
B
A

D
C
B
A

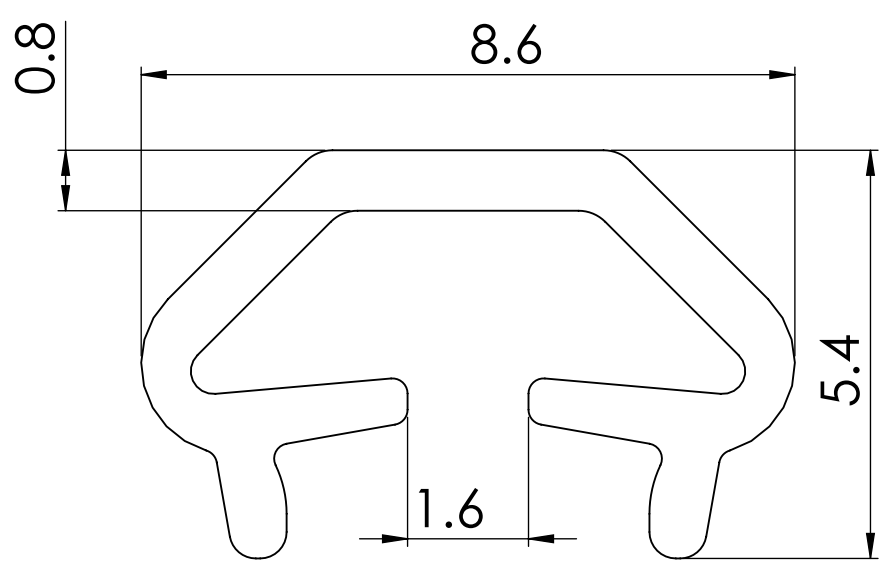
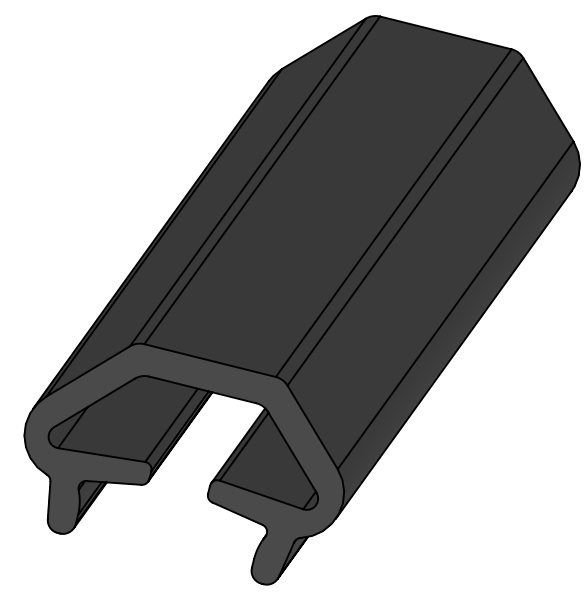

NOTE :-
ALL UNMENTIONED FILLETS ARE 0.2 MM

		UNLESS OTHERWISE SPECIFIED:		NAME	DATE		
		DIMENSIONS ARE IN MILLIMETERS	DRAWN			TITLE:	
		TOLERANCES:	CHECKED				
		FRACTIONAL ±	ENG APPR.				
		ANGULAR: MACH ± BEND ±	MFG APPR.				
		TWO PLACE DECIMAL ±	Q.A.			SIZE DWG. NO. REV	
		THREE PLACE DECIMAL ±	PROJECTION:				
		INTERPRET GEOMETRIC TOLERANCING PER: ISO 2768 MEDIUM				B 461518343	
		MATERIAL				SCALE: 1:10 WEIGHT: SHEET 1 OF 1	
NEXT ASSY	USED ON	FINISH					
APPLICATION		DO NOT SCALE DRAWING	DEBURR AND BREAK SHARP EDGES				

8 7 6 5 4 3 2 1