

8 7 6 5 4 3 2 1

D  
C  
B  
A

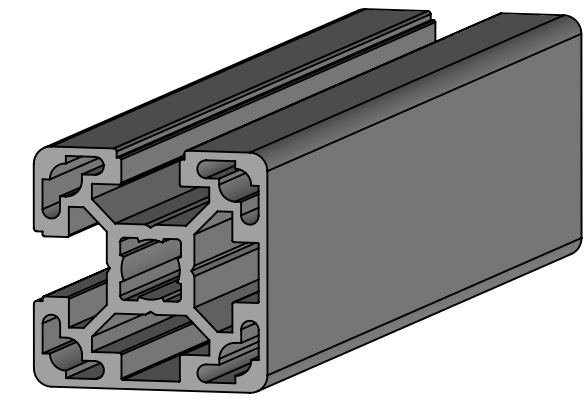
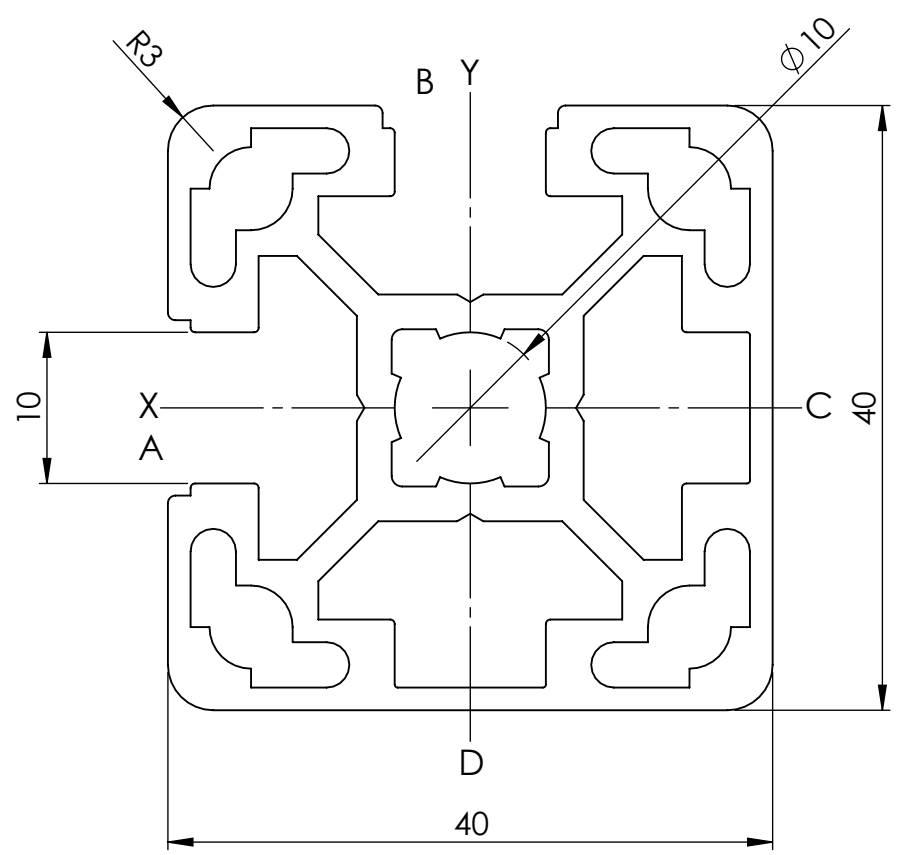

D  
C  
B  
A

NOTE :-  
ALL UNMENTIONED FILLETS ARE 0.2 MM

		UNLESS OTHERWISE SPECIFIED:		NAME	DATE			
		DIMENSIONS ARE IN MILLIMETERS	DRAWN			TITLE:		
		TOLERANCES:	CHECKED					
		FRACTIONAL ±	ENG APPR.					
		ANGULAR: MACH ± BEND ±	MFG APPR.					
		TWO PLACE DECIMAL ±	Q.A.			SIZE	DWG. NO.	REV
		THREE PLACE DECIMAL ±	PROJECTION:			<b>B</b>	411993189	
		INTERPRET GEOMETRIC TOLERANCING PER: ISO 2768 MEDIUM	THIRD ANGLE PROJECTION			SCALE: 1:2	WEIGHT:	SHEET 1 OF 1
		MATERIAL						
NEXT ASSY	USED ON	FINISH	DEBURR AND BREAK SHARP EDGES					
APPLICATION		DO NOT SCALE DRAWING						

8 7 6 5 4 3 2 1