

8 7 6 5 4 3 2 1

D
C
B
A

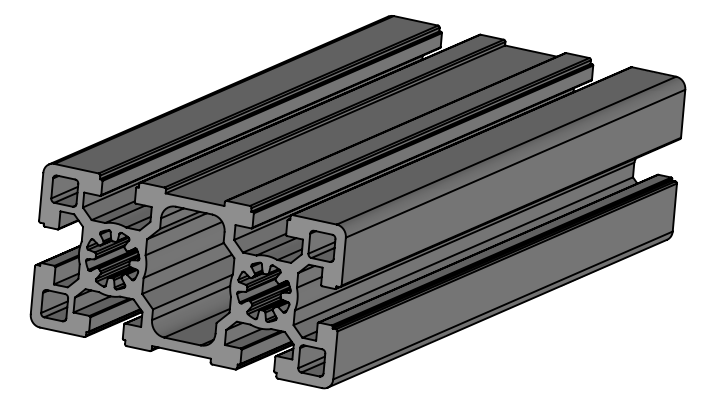
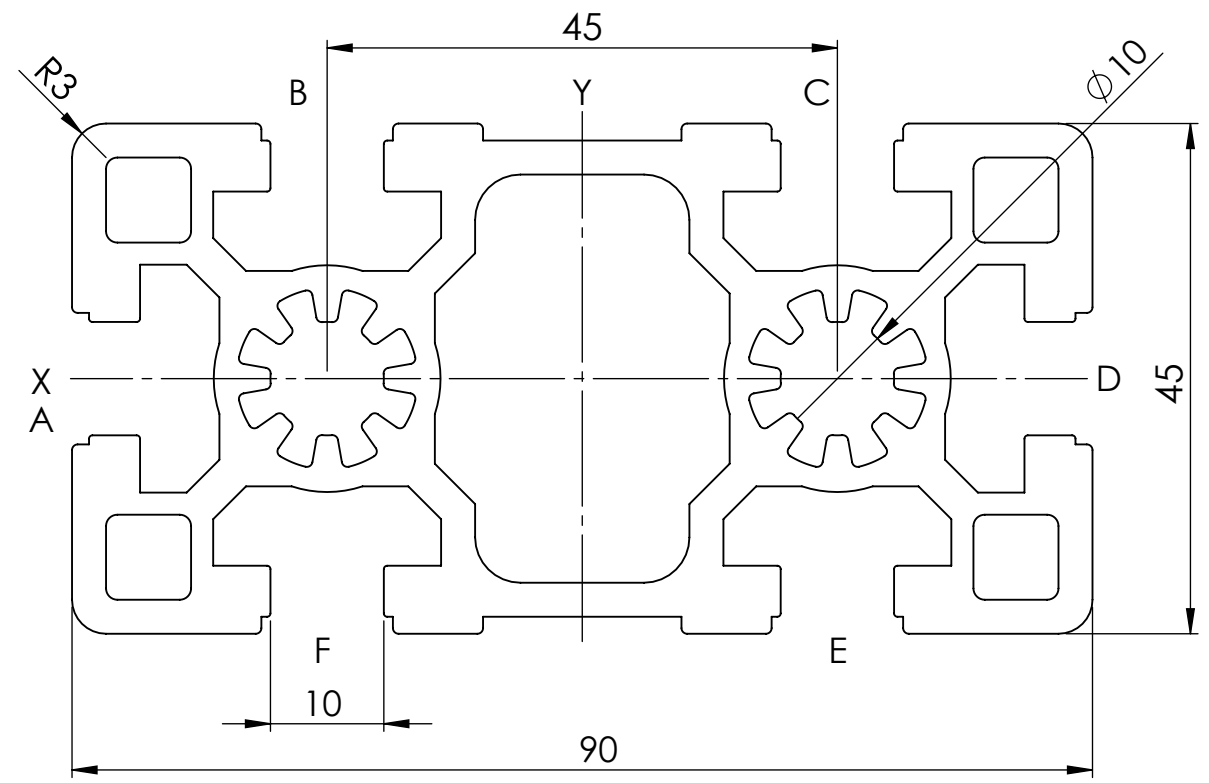

D
C
B
A

NOTE :-
ALL UNMENTIONED FILLETS ARE 0.2 MM

		UNLESS OTHERWISE SPECIFIED:		NAME	DATE	
		DIMENSIONS ARE IN MILLIMETERS	DRAWN			TITLE:
		TOLERANCES:	CHECKED			
		FRACTIONAL ±	ENG APPR.			
		ANGULAR: MACH ± BEND ±	MFG APPR.			
		TWO PLACE DECIMAL ±				
		THREE PLACE DECIMAL ±				
		INTERPRET GEOMETRIC TOLERANCING PER: ISO 2768 MEDIUM	Q.A.			
		MATERIAL	PROJECTION:			SIZE
		FINISH	THIRD ANGLE PROJECTION			DWG. NO.
NEXT ASSY	USED ON					REV
		DO NOT SCALE DRAWING	DEBURR AND BREAK SHARP EDGES			SCALE: 1:2
						WEIGHT:
						SHEET 1 OF 1

8 7 6 5 4 3 2 1