

8 7 6 5 4 3 2 1

D
C
B
A

D
C
B
A

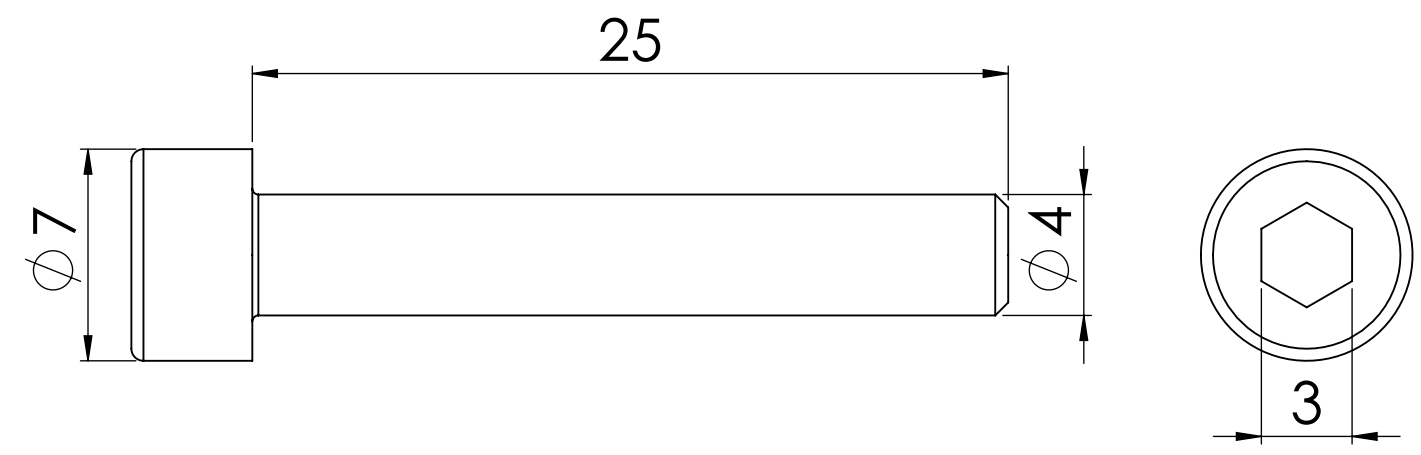
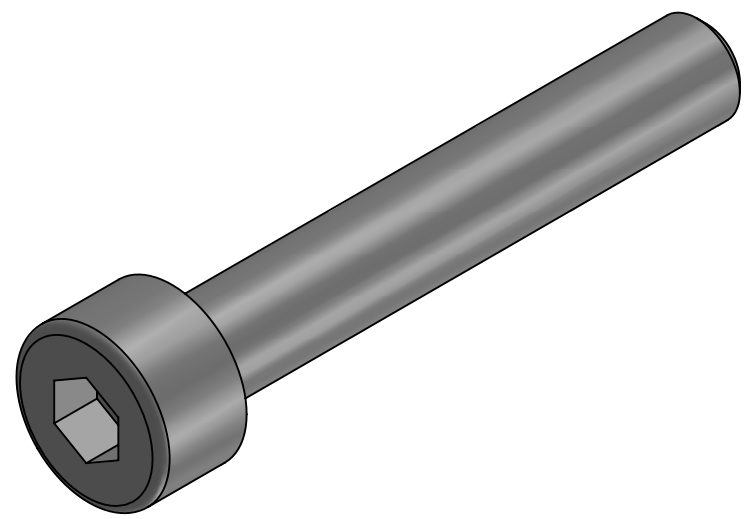

NOTE :-
ALL UNMENTIONED FILLETS ARE 0.2 MM

		UNLESS OTHERWISE SPECIFIED:		NAME	DATE			
		DIMENSIONS ARE IN MILLIMETERS	DRAWN			TITLE:		
		TOLERANCES:	CHECKED					
		FRACTIONAL ±	ENG APPR.					
		ANGULAR: MACH ± BEND ±	MFG APPR.					
		TWO PLACE DECIMAL ±	Q.A.			SIZE	DWG. NO.	REV
		THREE PLACE DECIMAL ±	PROJECTION:			B	402150323	
		INTERPRET GEOMETRIC TOLERANCING PER: ISO 2768 MEDIUM				SCALE: 2:1	WEIGHT:	SHEET 1 OF 1
		MATERIAL						
NEXT ASSY	USED ON	FINISH						
APPLICATION		DO NOT SCALE DRAWING	DEBURR AND BREAK SHARP EDGES					

8 7 6 5 4 3 2 1