

4

3

2

1

B

B

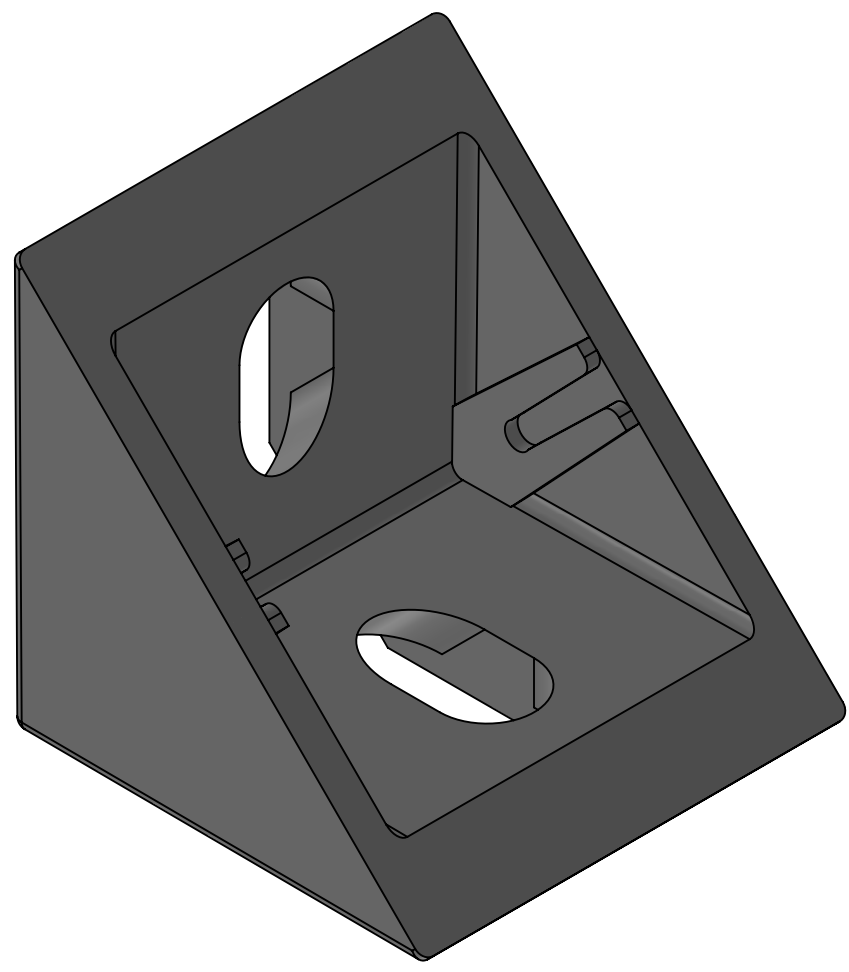
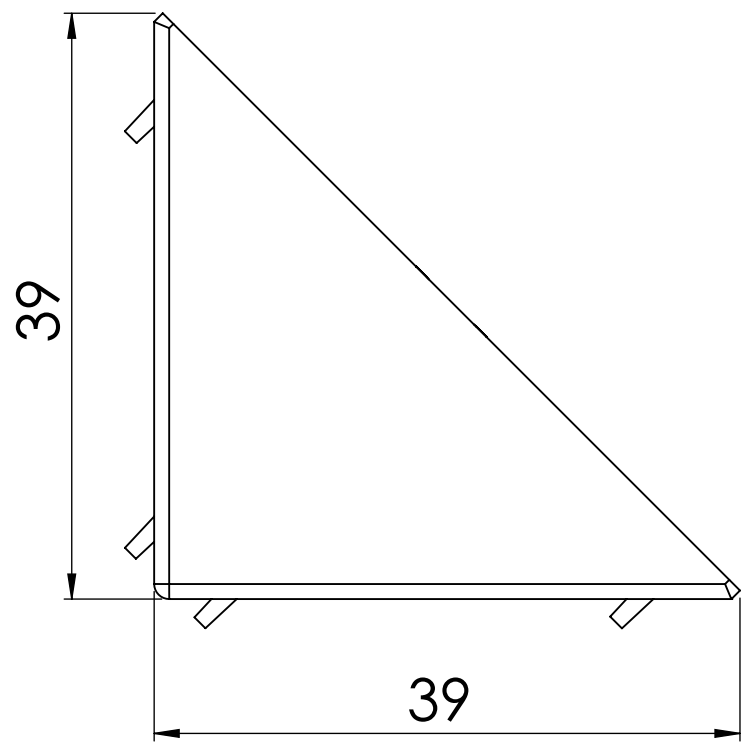
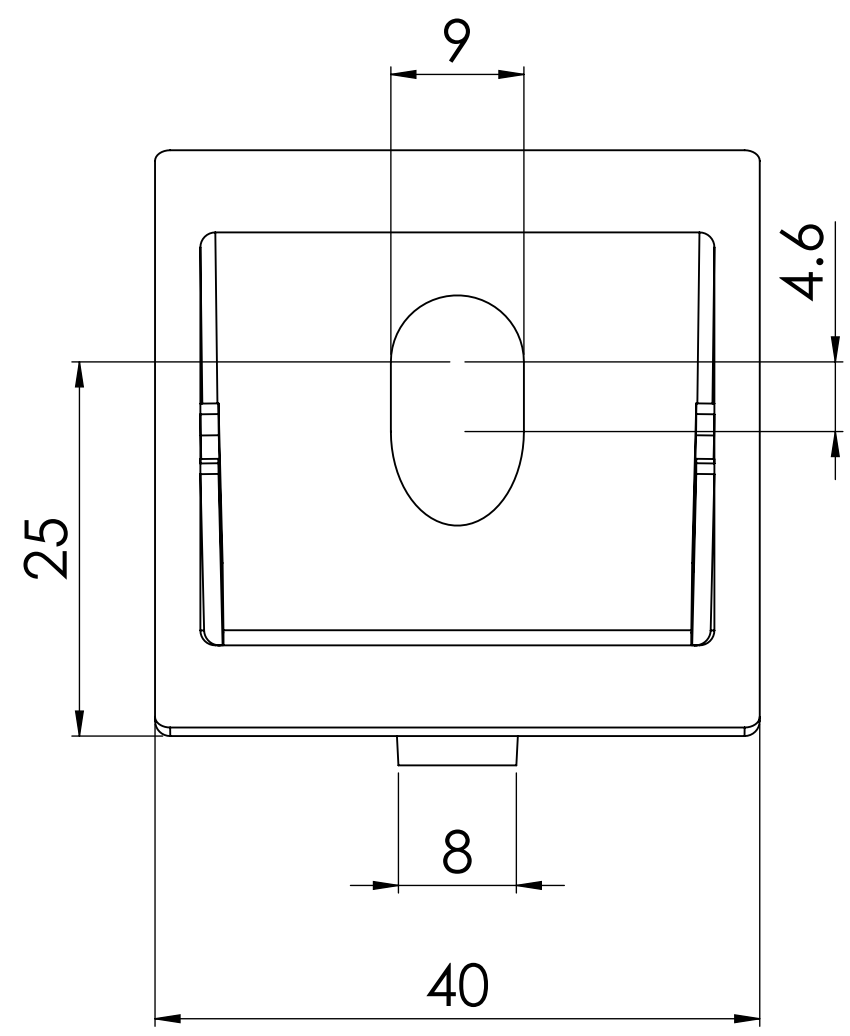

A

A

Note:-
*ALL UNMENTIONED FILLETS ARE 0.2MM

		UNLESS OTHERWISE SPECIFIED:	NAME	DATE		
		DIMENSIONS ARE IN MILLIMETERS	DRAWN			
		TOLERANCES:	CHECKED		TITLE:	
		FRACTIONAL ±	ENG APPR.			
		ANGULAR: MACH ± BEND ±	MFG APPR.			
		TWO PLACE DECIMAL ±	Q.A.			
		THREE PLACE DECIMAL ±	Projection:-		SIZE	DWG. NO.
		INTERPRET GEOMETRIC TOLERANCING PER:ISO 2768 MEDIUM	THIRD ANGLE PROJECTION		B	282300103
		MATERIAL			REV	
NEXT ASSY	USED ON	FINISH			SCALE: 2:1	WEIGHT:
APPLICATION		DO NOT SCALE DRAWING	DEBURR AND BREAK SHARP EDGES		SHEET 1 OF 1	

4

3

2

1