

8 7 6 5 4 3 2 1

D  
C  
B  
A

D  
C  
B  
A

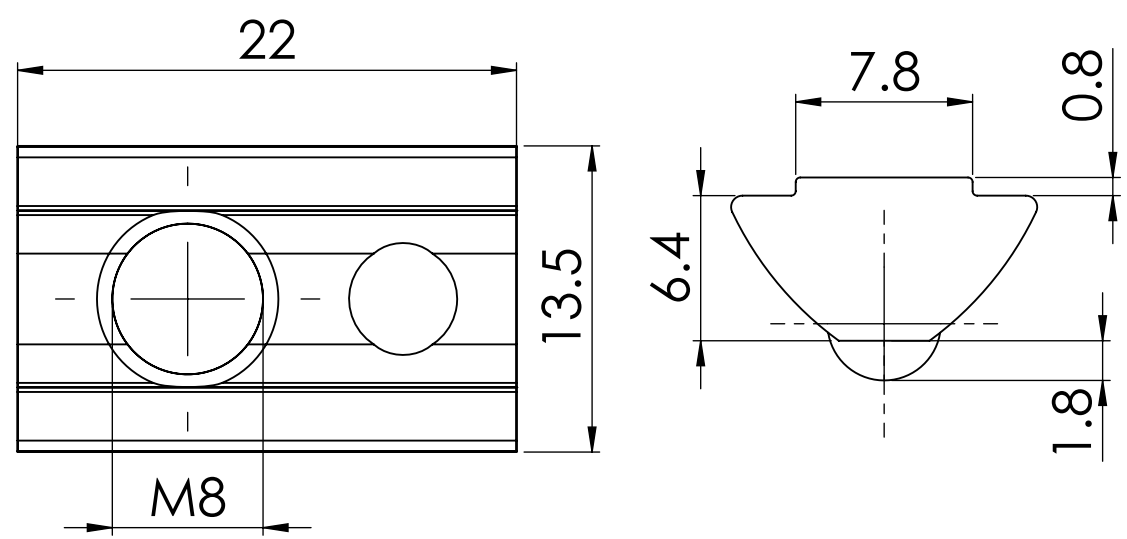
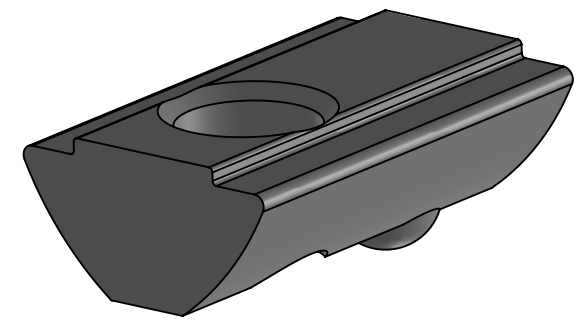

NOTE :-  
ALL UNMENTIONED FILLETS ARE 0.2 MM

		UNLESS OTHERWISE SPECIFIED:		NAME	DATE		
		DIMENSIONS ARE IN MILLIMETERS	DRAWN			TITLE:	
		TOLERANCES:	CHECKED				
		FRACTIONAL ±	ENG APPR.				
		ANGULAR: MACH ± BEND ±	MFG APPR.				
		TWO PLACE DECIMAL ±	Q.A.			SIZE DWG. NO. REV	
		THREE PLACE DECIMAL ±	PROJECTION:				
		INTERPRET GEOMETRIC TOLERANCING PER: ISO 2768 MEDIUM	THIRD ANGLE PROJECTION			B 282200118	
		MATERIAL					
NEXT ASSY	USED ON	FINISH	DEBURR AND BREAK SHARP EDGES			SCALE: 2:1	WEIGHT:
APPLICATION		DO NOT SCALE DRAWING				SHEET 1 OF 1	

8 7 6 5 4 3 2 1