

# Spacers 24x14,6x5

Article Number: 300007697



## Technical Data

Attribute	Value
RoHS	RoHS compliant
Colour	black
Country of origin	Germany
Customs tariff number	39269097
Material	PA 6
Previous part number	05-24-14,5-5S
Weight	1,62 g
External diameter	24,0 mm
Flammability	UL 94 V-2
Height	5 mm
Internal diameter	14,6 mm
Shape	round
Version	standard

## Description

PA 6 spacers black in the dimensions 24x14,6x5 - the ideal solution for reliable and precise distance adjustment between different components. Thanks to their low weight, they are easy and simple to handle. Quality from Germany: emico spacer sleeves are manufactured in Germany and meet the highest quality standards. The first-class PA 6 material guarantees a long service life. The spacers are also RoHS compliant.

Please note: Not a stock item. This item is manufactured upon request

## Drawing and Dimension Table

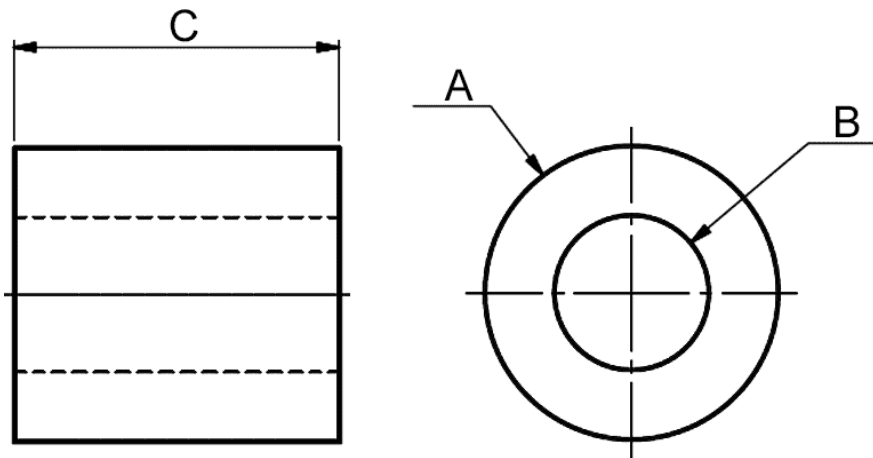

Attribute	Value
A	24,0 mm
B	14,6 mm
C	5,0 mm



Scan the QR code to discover more items in this category.

For personalized advice, feel free to contact us at [sales@emico.com](mailto:sales@emico.com) or by phone at +49 9621 67545-0.

*The information in this document is provided to the best of our knowledge, but without guarantee. Changes and errors reserved.*